



**SCHLAGE**

# A Series

Cylindrical locks





## Contents

|       |                                                |
|-------|------------------------------------------------|
| 4-5   | Mechanical lock guide                          |
| 6     | A Series introduction and performance features |
| 7     | Exploded view                                  |
| 8     | Knob and lever designs                         |
| 9     | Knob designs and finishes                      |
| 9     | Door handing                                   |
| 10-11 | Lock functions                                 |
| 12    | Cylinder types                                 |
| 13    | Standard cylinders                             |
| 13    | Primus XP high security cylinders              |
| 14    | Interchangeable core                           |
| 15    | IC conversion kits                             |
| 15    | IC installation tool                           |
| 16    | Latches                                        |
| 17    | Strikes                                        |
| 17    | Rabbeted latch and strike kit                  |
| 18    | Specifications and certifications              |



Pictured here: Levon lever shown  
in 626 satin chrome

Cover photo: Orbit knob shown  
in 626 satin chrome

Be sure to ask your SSC representative to tell you about **Custom Solutions** by Allegion.  
To learn more visit [allegion.com/us](http://allegion.com/us).



**Quiet**Solutions



**Custom**Décor



**High**Security and Safety



**Environmental**Solutions



**Flexible**Configurations

# Put your trust in the name you know





For more than 90 years, Schlage has been creating the strongest and most technologically advanced security products for schools, hospitals, hotels, commercial and institutional buildings, multi-family properties and homes. From durable mechanical locks to comprehensive electronic access control solutions and biometrics, Schlage provides protection at critical moments – when property and personal security are at stake. With a wide range of products, styles and finishes, Schlage has products for the most demanding project specifications. In public buildings, in the workplace, and in homes, at the end of the day Schlage stands for one thing: strong.

## Real security is knowing exactly what you want and getting it



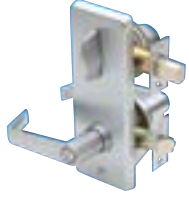

When you know exactly what you want, you don't want to waste time finding out whether it meets your project specifications. That's why we offer the world's largest team of hardware specification writers to help you and your clients turn your vision into reality. And when it comes to products, our commercial suiting options, wide variety of lever designs and rich selection of finishes give you the tools you need to make your projects perfect. You know what you want. With Schlage, you can be sure you'll get it.

### Safety, security and confidence

When you choose a Schlage lock, you can be sure you've done the job right, the first time. After all, our products are among the most durable and dependable on the market today. Our locks are easy to install, and simple to repair and maintain. That means fewer callbacks for you, and total safety and security for your customers.

|                                                                                                              |                                                                                        |                                                                                    |                                                                                     |                                                                                               |
|--------------------------------------------------------------------------------------------------------------|----------------------------------------------------------------------------------------|------------------------------------------------------------------------------------|-------------------------------------------------------------------------------------|-----------------------------------------------------------------------------------------------|
|                             |       |   |   |            |
| <b>Tubular interconnected locks</b>                                                                          | <b>Tubular locks</b>                                                                   | <b>Tubular interconnected locks</b>                                                | <b>Cylindrical locks</b>                                                            | <b>Cylindrical interconnected locks</b>                                                       |
| CS200 Series                                                                                                 | S Series                                                                               | S200 Series                                                                        | A Series                                                                            | H Series                                                                                      |
| Grade 2                                                                                                      | Grade 2                                                                                |                                                                                    | Grade 2                                                                             |                                                                                               |
| <b>Security level:</b>                                                                                       |                                                                                        |                                                                                    |                                                                                     |                                                                                               |
| ANSI/BHMA certified<br>A156.2-2013<br>Exceeds 400,000 ANSI cycles<br>Medium traffic                          | ANSI/BHMA certified<br>A156.2-2011<br>Exceeds 400,000 ANSI cycles<br>Light traffic     | -<br>-<br>Exceeds 400,000 ANSI cycles<br>Medium traffic                            | ANSI/BHMA certified<br>A156.2-2011<br>Exceeds 400,000 ANSI cycles<br>Medium traffic | -<br>-<br>Exceeds 400,000 ANSI cycles<br>Medium traffic                                       |
| <b>Typical applications:</b>                                                                                 |                                                                                        |                                                                                    |                                                                                     |                                                                                               |
| Exterior<br>Interior<br>New construction<br>Retrofit                                                         | -<br>Interior<br>-<br>Retrofit                                                         | Exterior<br>Interior<br>New construction<br>Retrofit                               | Exterior<br>Interior<br>New construction<br>Retrofit                                | Exterior<br>Interior<br>-<br>Retrofit                                                         |
| <b>Functions available:</b>                                                                                  |                                                                                        |                                                                                    |                                                                                     |                                                                                               |
| 1 Function<br>-<br>-                                                                                         | 6 Functions<br>-<br>-                                                                  | 5 Functions<br>-<br>-                                                              | 11 Functions<br>-<br>-                                                              | 5 Functions<br>-<br>-                                                                         |
| <b>Design options:</b>                                                                                       |                                                                                        |                                                                                    |                                                                                     |                                                                                               |
| 7 Finishes<br>15 Lever styles<br>-<br>1 Matching rose<br>2 Interior escutcheons<br>Tactile warning available | 7 Finishes<br>4 Lever styles<br>-<br>1 Matching rose<br>-<br>Tactile warning available | 7 Finishes<br>4 Lever styles<br>-<br>1 Matching rose<br>1 Interior escutcheon<br>- | 10 Finishes<br>1 Lever style<br>4 Knob styles<br>1 Matching rose<br>-<br>-          | 7 Finishes<br>1 Lever style<br>2 Knob styles<br>1 Matching rose<br>1 Interior escutcheon<br>- |
| <b>Often used in:</b>                                                                                        |                                                                                        |                                                                                    |                                                                                     |                                                                                               |
| Commercial<br>Multi-family<br>Office                                                                         | Commercial<br>Multi-family<br>Office                                                   | Commercial<br>Multi-family<br>Office                                               | Commercial<br>Govt/military<br>Healthcare<br>Hospitality<br>Office<br>Retail        | Commercial<br>Govt/military<br>Multi-family                                                   |

Not all functions and finishes available with all products. Please consult your SSC representative for details.

|                                                                                         |                                                                                                        |                                                                                     |                                                                                           |                                                                                                                                            |                                                      |
|-----------------------------------------------------------------------------------------|--------------------------------------------------------------------------------------------------------|-------------------------------------------------------------------------------------|-------------------------------------------------------------------------------------------|--------------------------------------------------------------------------------------------------------------------------------------------|------------------------------------------------------|
|        |                       |    |         |                                                         |                                                      |
| <b>Cylindrical locks</b>                                                                | <b>Deadbolts</b>                                                                                       | <b>Cylindrical locks</b>                                                            | <b>Cylindrical locks</b>                                                                  | <b>Mortise locks</b>                                                                                                                       |                                                      |
| <b>AL Series</b>                                                                        | <b>B Series</b>                                                                                        | <b>D Series</b>                                                                     | <b>ND Series</b>                                                                          | <b>L Series</b>                                                                                                                            |                                                      |
| <b>Grade 2</b>                                                                          | <b>Grade 2</b>                                                                                         | <b>Grade 1</b>                                                                      | <b>Grade 1</b>                                                                            | <b>Grade 1</b>                                                                                                                             |                                                      |
| <b>Security level:</b>                                                                  |                                                                                                        |                                                                                     |                                                                                           |                                                                                                                                            |                                                      |
| ANSI/BHMA certified<br>A156.2-2011<br>Exceeds 400,000 ANSI cycles<br>Medium traffic     | ANSI/BHMA certified<br>A156.5-2010<br>Exceeds 150,000/250,000 ANSI cycles<br>High traffic, heavy-duty  | ANSI/BHMA certified<br>A156.2-2011<br>Exceeds 1,000,000 ANSI cycles<br>High traffic | ANSI/BHMA certified<br>A156.2-2011<br>Exceeds 1,000,000 ANSI cycles<br>Heavy-duty traffic | ANSI/BHMA certified<br>A156.13-2012<br>Exceeds 1,000,000 ANSI cycles<br>Heavy-duty traffic                                                 |                                                      |
| <b>Typical applications:</b>                                                            |                                                                                                        |                                                                                     |                                                                                           |                                                                                                                                            |                                                      |
| Exterior<br>Interior<br>New construction<br>Retrofit                                    | Exterior<br>-<br>New construction<br>Retrofit                                                          | Exterior<br>Interior<br>-<br>Retrofit                                               | Exterior<br>Interior<br>New construction<br>Retrofit                                      | Exterior<br>Interior<br>New construction<br>Retrofit                                                                                       |                                                      |
| <b>Functions available:</b>                                                             |                                                                                                        |                                                                                     |                                                                                           |                                                                                                                                            |                                                      |
| 10 Functions<br>-<br>-                                                                  | 7 Functions<br>-<br>-                                                                                  | 6 Functions<br>-<br>-                                                               | 14 Functions<br>2 Electrified<br>-                                                        | 29 Functions<br>6 Electrified<br>Vandgard® available                                                                                       | 49 Functions<br>4 Electrified<br>Vandgard® available |
| <b>Design options:</b>                                                                  |                                                                                                        |                                                                                     |                                                                                           |                                                                                                                                            |                                                      |
| 10 Finishes<br>4 Lever styles<br>-<br>1 Matching rose<br>-<br>Tactile warning available | 10 Finishes<br>-<br>-<br>-<br>-<br>Indicator rose                                                      | 10 Finishes<br>-<br>3 Knob styles<br>1 Matching rose<br>-<br>-                      | 9 Finishes<br>5 Lever styles<br>-<br>2 Matching roses<br>-<br>Tactile warning available   | 13 Finishes<br>26 Lever style<br>3 Knob styles<br>4 Matching roses<br>2 Escutcheons<br>Tactile warning available<br>Antiligature available |                                                      |
| <b>Often used in:</b>                                                                   |                                                                                                        |                                                                                     |                                                                                           |                                                                                                                                            |                                                      |
| Commercial<br>Healthcare<br>Hospitality<br>Office<br>Retail                             | Commercial/institutional<br>Govt/military<br>Heavy-duty residential<br>Hospitality<br>Office<br>Retail | Institutional<br>Govt/military<br>Hospitality<br>Retail                             | Institutional<br>Education<br>Healthcare<br>Office<br>Retail                              | Commercial/institutional<br>Govt/military<br>Education<br>Healthcare<br>Office<br>Retail                                                   |                                                      |

This chart shows the most common uses/applications. These products are often used in other applications in addition to those listed.

Rev. 11/13

# A Series

## Medium traffic commercial and heavy-duty residential locks

From military barracks and offices, to fine residential homes, Schlage A Series knobs easily stand up to constant use and abuse, while keeping people and property safe. Our A Series locks have an ANSI Grade 2 rating and come in a choice of styles and finishes that fit your building's design.

## We don't compromise on security

The safety and security of your buildings is something we take very seriously. That's why every Schlage lock and deadbolt undergoes intensive testing to determine its ANSI grade level:

- Cycle tests
- Resistance tests
- Door impact tests
- Warped door tests
- Bolt strength tests

Pictured here: Tulip knob shown in 626 satin chrome



# The lock that's built to last

- Cold-rolled steel, and machined and threaded hubs prevent loosening of the lockset by bolting the chassis to the door.
- Heavy-duty cast mounting plate with specially tapped holes, keeps lockset tight on the door.
- Patented door range adjuster allows quick and easy adjustment for doors ranging from 1<sup>3</sup>/<sub>8</sub>" to 1<sup>7</sup>/<sub>8</sub>" (35 mm to 48 mm) thick

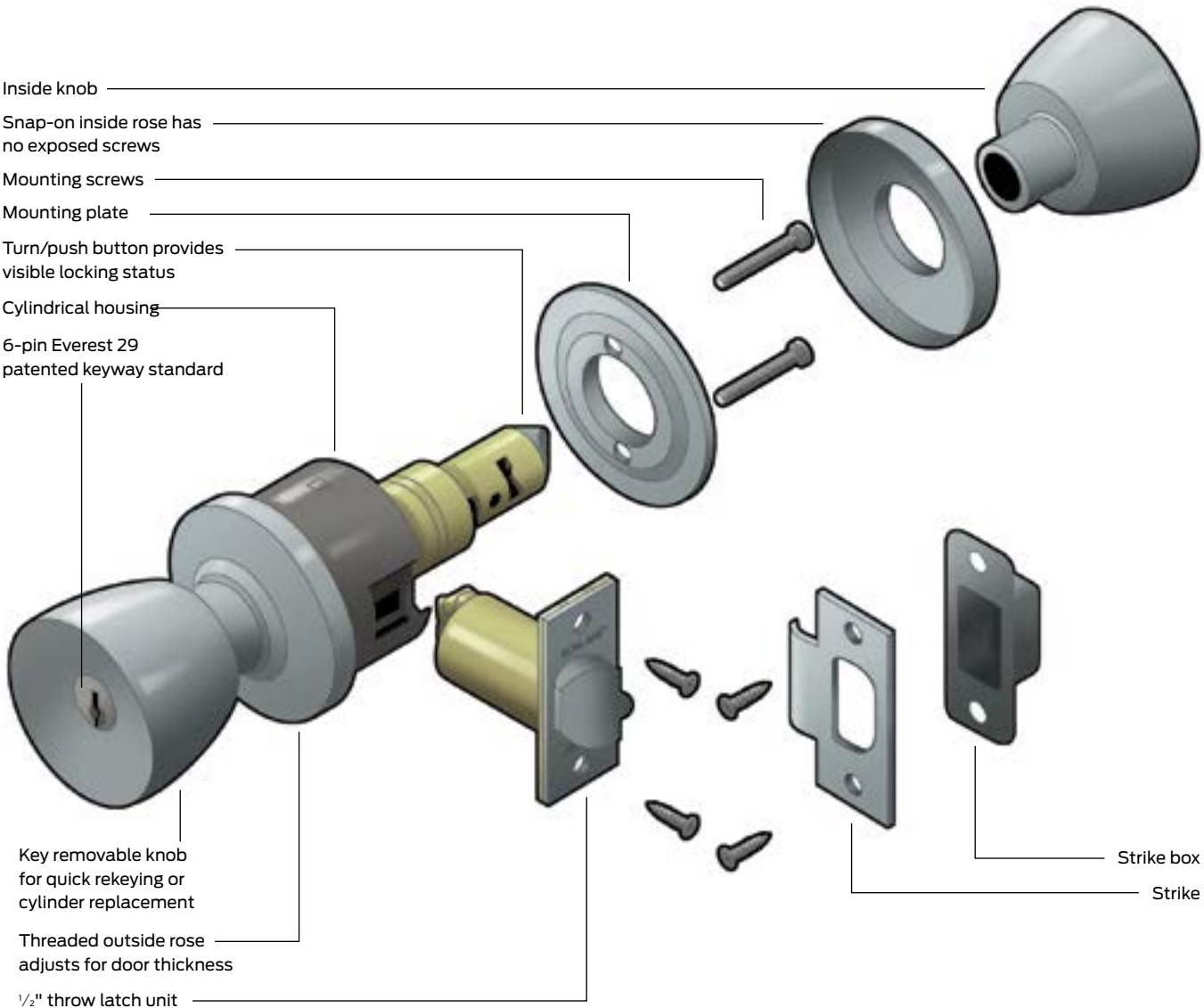

# A Series knob and lever designs

## Georgian (GEO)

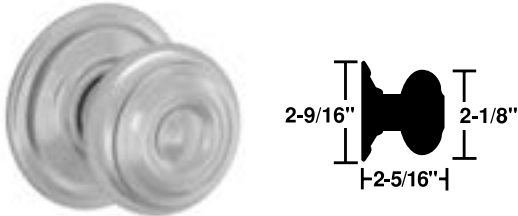

**Symbol:** GEO  
**Material:** Wrought brass



## Plymouth (PLY)

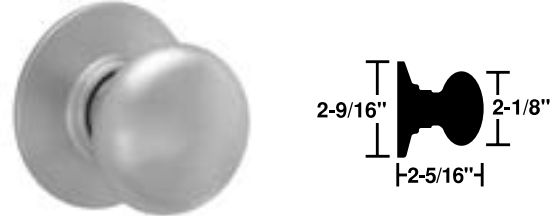

**Symbol:** PLY  
**Material:** Wrought brass, bronze or stainless steel



## Orbit (ORB)

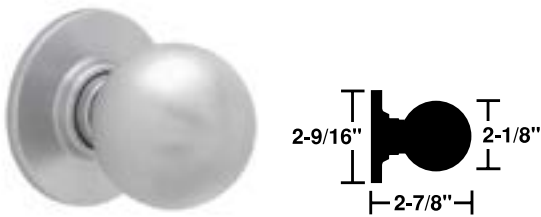

**Symbol:** ORB  
**Material:** Wrought brass or bronze



## Tulip (TUL)



**Symbol:** TUL  
**Material:** Wrought brass



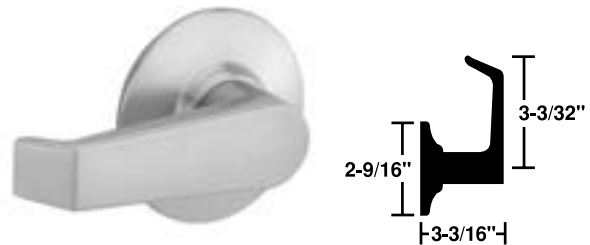

## Levon (LEV)



**Symbol:** LEV  
**Material:** Pressure cast zinc lever; wrought brass or bronze rose  
**Note:** On keyed functions the LEV lever is available for inside trim only.



All designs shown in 626 satin chrome

-  = Standard cylinder.
-  = FSIC - full size interchangeable core option for Orbit design.
-  = Complies with ADA accessibility guidelines.



# Knob and lever finishes

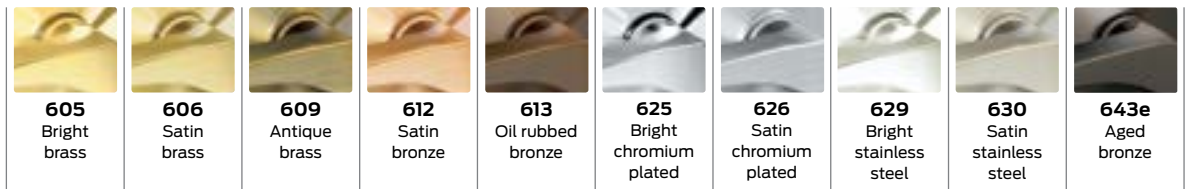

| A Series locks |   |   |   |   |   |   |   |   |   |   |
|----------------|---|---|---|---|---|---|---|---|---|---|
| Georgian       | • | • | • |   |   | • | • |   |   | • |
| Orbit          | • | • | • | • | • | • | • |   |   | • |
| Plymouth       | • | • | • | • | • | • | • | • | • | • |
| Tulip          | • | • | • |   |   | • | • |   |   | • |
| Levon          | • |   |   | • | • |   | • |   |   | • |

e = an equivalent finish to the BHMA standard.

# Door handing

Many Schlage locks are reversible. Hand information is necessary to ensure proper cylinder orientation in keyed functions, and finish of latchbolt and strike for locks that are to be installed on reverse bevel doors. Follow the diagram to correctly determine the hand of the door.

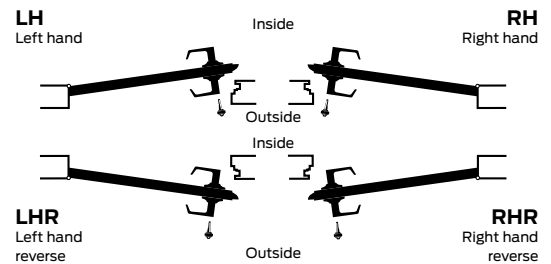

# ADA-compliant products

In compliance with the American National Standards Institute (ANSI A117.1) and the Americans with Disabilities Act (ADA), Schlage Lock Company offers a wide selection of locks designed for the needs of the physically challenged. This act is designed to provide protection for people with disabilities.

The intent of ADA is that owners of certain types of buildings must remove barriers and provide people with disabilities with access equal to, or similar to, that available to the general public.

Product information and specifications contained in this catalog are subject to change without notice. Please consult the factory.

# A Series lock functions

## ANSI A156.2 Series 4000 Grade 2

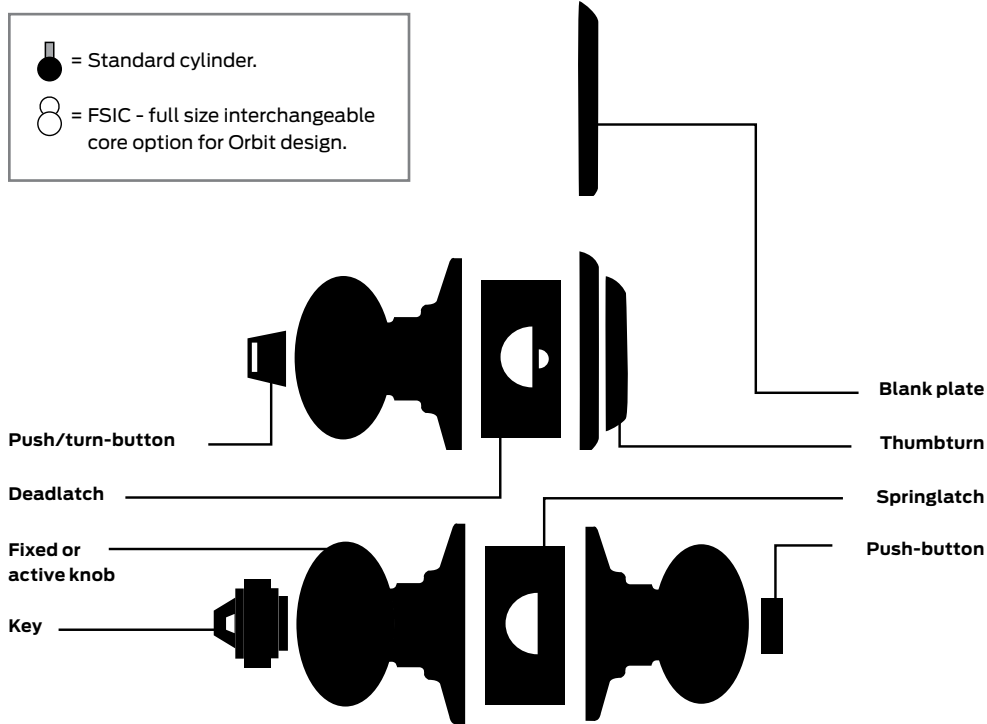

### Non-keyed functions

Schlage                      ANSI  
**A10**                              **F75**

#### Passage latch

- Both knobs always unlocked.

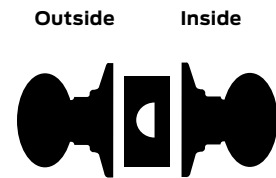

Schlage

**A25D**

#### Exit lock

- Blank plate outside.
- Inside knob is always unlocked.
- Specify door thickness.

Outside      Inside



Schlage

**A30D**

#### Patio lock

- Push-button locking.
- Turn inside knob or close door to release button and prevent lock-out.

Outside      Inside



ANSI

**F77S**

Schlage

**A40**

#### Bath/bedroom privacy lock

- Push-button locking.
- Can be opened from outside with small screwdriver.
- Turn inside knob or close door to release button.

Outside      Inside



ANSI

**F76**

Schlage

**A43**

#### Communicating lock

- Turn-button in outer knob locks and unlocks knob and inside thumbturn.

Outside      Inside



## Keyed functions

Schlage

**A170**

### Single dummy trim

- Dummy trim for one side of door.
- Used for door pull or as matching inactive trim.

Outside/Inside



Schlage

**A53**

ANSI

**F109**

### Entrance lock

- Turn/push-button locking: pushing and turning button locks the outside knob, requiring use of a key until button is manually unlocked.
- Push-button locking: pushing button locks outside knob until it is unlocked by key or by turning the inside knob.

Outside Inside



● 8 ORB

Schlage

**A70**

ANSI

**F84**

### Classroom lock

- Outside knob is locked and unlocked by key.
- Inside knob is always unlocked.

Outside Inside



● 8 ORB

Schlage

**A79**

### Communicating lock with blank plate

- Locked or unlocked by key from outside.
- Blank plate inside.

Outside Inside

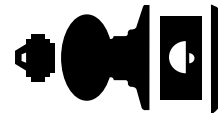

● 8 ORB

Schlage

**A80**

ANSI

**F86**

### Storeroom lock

- Outside knob is fixed.
- Entrance by key only.
- Inside knob always unlocked.

Outside Inside



● 8 ORB

Schlage

**A85**

ANSI

**F93**

### Faculty restroom lock

- Outside knob is fixed.
- Entrance by key only.
- Push-button on inside knob activates visual occupancy indicator, allowing only the emergency master key to operate.
- Rotation of inside spanner button provides lock-out feature by keeping indicator thrown.

Outside Inside



●





# Cylinders and key systems

## Protect new key systems with Everest 29

Schlage can help you design a system that can grow and change along with your needs, allowing you the flexibility to upgrade your security without the need to replace all your cylinders.

## Upgrade existing classic key systems with Primus XP

Schlage offers key system solutions that are ideal for upgrading an existing key system to control key management. Our patent-protected cylinders help prevent unauthorized duplication and can be integrated into virtually any existing system.

| What it operates                                                                                                                                                         |                                                                                                                                                                                                                                                                                                                                                                                                                                                                     | What it is                                                                                                                                                   |                                                                                                                                                                                                                                                                                                                                                                                                                                                                                                                                                                 |
|--------------------------------------------------------------------------------------------------------------------------------------------------------------------------|---------------------------------------------------------------------------------------------------------------------------------------------------------------------------------------------------------------------------------------------------------------------------------------------------------------------------------------------------------------------------------------------------------------------------------------------------------------------|--------------------------------------------------------------------------------------------------------------------------------------------------------------|-----------------------------------------------------------------------------------------------------------------------------------------------------------------------------------------------------------------------------------------------------------------------------------------------------------------------------------------------------------------------------------------------------------------------------------------------------------------------------------------------------------------------------------------------------------------|
| <ul style="list-style-type: none"> <li>Everest 29 Primus<sup>®</sup> XP cylinders</li> <li>Everest 29 restricted cylinders</li> <li>Everest 29 open cylinders</li> </ul> | <ul style="list-style-type: none"> <li>UL 437 version</li> <li>UL 437 versions provide drill and pick resistance and withstand physical attack</li> <li>High security cylinders have a second set of pins for added security</li> <li>Patented key control sold with various levels of geographic exclusivity</li> <li>Keys operate high security, as well as restricted security or standard security cylinders</li> <li>Available only in conventional</li> </ul> | <ul style="list-style-type: none"> <li>Everest 29 Primus XP cylinders</li> <li>Everest 29 restricted cylinders</li> <li>Everest 29 open cylinders</li> </ul> | <ul style="list-style-type: none"> <li>Controlled access</li> <li>Patented key control sold with various levels of geographic exclusivity</li> <li>High security cylinders have a second set of pins for added security and pick resistance</li> <li>Keys operate high security, as well as restricted security or standard security cylinders</li> <li>Available only in conventional and FSIC</li> </ul>  <p><b>EVEREST 29<sup>™</sup> PRIMUS XP</b><br/>High security</p> |
| <ul style="list-style-type: none"> <li>Everest 29 restricted cylinders</li> </ul>                                                                                        | <ul style="list-style-type: none"> <li>Key distribution is restricted duplication must be authorized</li> <li>End user's ID numbers are stamped on all keys, enabling Schlage to identify the source of any unauthorized keys</li> <li>Patent-protected keys are drop-shipped from the factory directly to an end-user specified location to guarantee exclusivity</li> <li>Available in conventional, SFIC and FSIC</li> </ul>                                     | <ul style="list-style-type: none"> <li>Everest 29 open cylinders</li> </ul>                                                                                  | <ul style="list-style-type: none"> <li>Controlled access</li> <li>Patented key control sold with various levels of geographic exclusivity</li> <li>High security cylinders have a second set of pins for added security and pick resistance</li> <li>Keys operate high security, as well as restricted security or standard security cylinders</li> <li>Available only in conventional</li> </ul>  <p><b>EVEREST 29<sup>™</sup></b><br/>Restricted security</p>              |
| <ul style="list-style-type: none"> <li>Everest 29 open cylinders</li> </ul>                                                                                              | <ul style="list-style-type: none"> <li>Patented key blanks can be stored by commercial locksmiths and security dealers</li> <li>Keys can be duplicated without any paperwork or signature verification</li> <li>Sold only through commercial outlets</li> <li>Available in conventional and FSIC</li> </ul>                                                                                                                                                         | <ul style="list-style-type: none"> <li>Primus XP cylinders</li> <li>Classic cylinders</li> </ul>                                                             | <ul style="list-style-type: none"> <li>Controlled access</li> <li>Patented key control sold with various levels of geographic exclusivity</li> <li>High security cylinders have a second set of pins for added security and pick resistance</li> <li>Keys operate high security, as well as restricted security or standard security cylinders</li> <li>Available only in conventional</li> </ul>  <p><b>PRIMUS XP</b><br/>High security</p>                                 |
|                                                                                                                                                                          |                                                                                                                                                                                                                                                                                                                                                                                                                                                                     | <ul style="list-style-type: none"> <li>Classic cylinders</li> </ul>                                                                                          | <ul style="list-style-type: none"> <li>Basic security</li> </ul>  <p><b>CLASSIC</b><br/>Basic security</p>                                                                                                                                                                                                                                                                                                                                                                   |

## Standard cylinders



Standard cylinders are available in the patented Everest 29 or Classic keyways. Standard keyways are the Everest 29 S123 and S145 (factory masterkeyed systems). All other keyways available when requested.

**Cylinder for most functions**

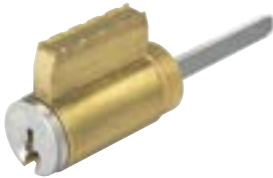

**Hotel function indicator cylinder**



### Standard cylinders - options

- 6-pin conventional (standard)
- Primus high security
- Primus UL437 Listed high security
- Hotel function (A85) with indicator

Available in 606 and 626 finish only. Everest 29 S123 keyway standard for commercial; C keyway standard for residential.

## Primus XP access control and high security cylinders

Primus XP access control and high security cylinders are available to add patented key control and varying degrees of geographical exclusivity to most Schlage 6-pin key systems, whether Everest 29™ or Classic keyways.

In addition to a conventional pin tumbler mechanism, Primus cylinders incorporate a patented finger pin and sidebar design, providing a “dual-locking” cylinder that is virtually pick-proof. Resistance to drilling and other physical attack is optional by specifying 20-500 Series UL437 Listed cylinders.

Classic Primus XP cylinders are recommended for upgrading existing Classic key systems. Due to its extended patent life, the newly designed Everest 29 Primus XP is recommended for new key systems and for upgrading existing Everest key systems. Specify keyway to differentiate between Everest 29 and Classic. Example: C or CP (Classic) vs. S123 (Everest 29).

**Visit [allegion.com/us](http://allegion.com/us) for more information.**

## Full size interchangeable core 8

Schlage FSIC full size interchangeable core (IC) locksets allow immediate rekeying at the door simply by using the special control key to replace the core in seconds.

IC locksets are available in Orbit design only.



## Cores only

**Full size interchangeable cores - options**  
(For JD suffix locksets)

- Conventional core
- Primus® XP high security core

Available in 606 and 626 finish only. Everest 29 S123 keyway standard for commercial; C keyway standard for residential.

FSIC - full size interchangeable core option for Orbit design.

**Full size core**



# FSIC conversion kits

It is easy to convert standard A Series locksets to accept Schlage FSIC interchangeable cores by changing the knob and adding the parts shown.

## Interchangeable core components - options

- Conversion kit: driver, retainer, knob, core
- Conversion kit: driver, retainer, knob
- Knob only (Orbit)
- IC installation tool

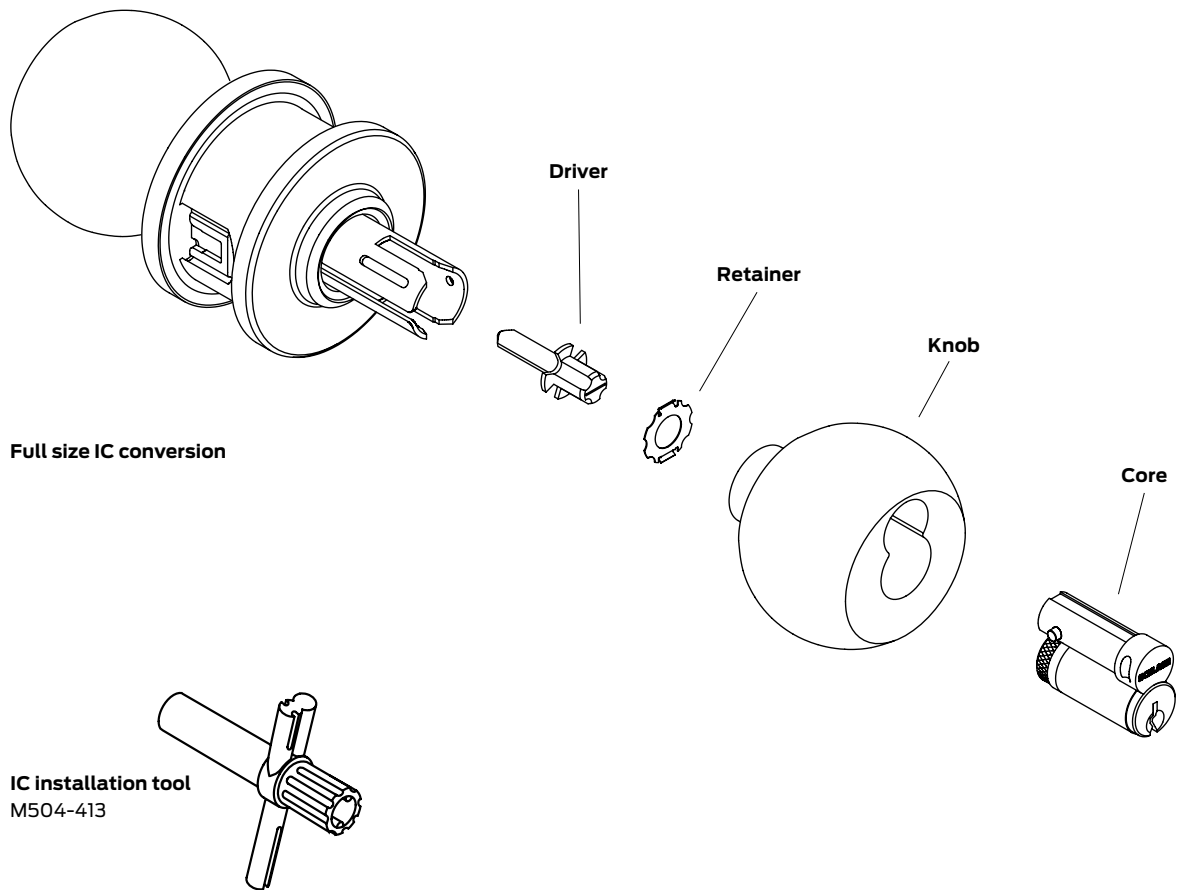

# Latches

A Series latches are adjustable for flat or beveled edge doors. Latches and strikes are furnished in brass, bronze, or chrome finishes, compatible with lock trim. When ordering separately, specify quantity, part number, and finish. Standard latches shown in bold type.

## Square corner latches

Springlatch

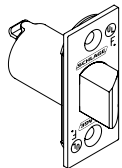

Deadlatch

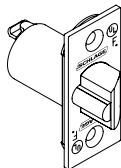

## Round corner latches

Springlatch

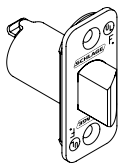

Deadlatch

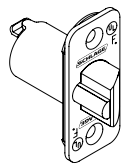

## Drive-in latches

Springlatch

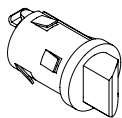

Deadlatch

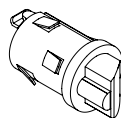

## Latches

| Backset           | Faceplate description                                        | Hsg dia             | Deadlatch<br>1/2" (13 mm) throw |
|-------------------|--------------------------------------------------------------|---------------------|---------------------------------|
| 2 3/8"<br>(60 mm) | <b>1" x 2 1/4" (25 mm x 57 mm) square corner, standard</b>   | <b>7/8" (22 mm)</b> | <b>11-085</b>                   |
|                   | 1" x 2 1/4" (25 mm x 57 mm) 1/4" (6 mm) radius, round corner | 7/8" (22 mm)        | 11-088                          |
|                   | 1" (25 mm) circular drive-in (non-UL)                        | 1" (25 mm)          | 11-104                          |
| 2 3/4"<br>(70 mm) | 1" x 2 1/4" (25 mm x 57 mm) square corner                    | 7/8" (22 mm)        | 11-091                          |
|                   | 1 1/8" x 2 1/4" (29 mm x 57 mm) square corner                | 1" (25 mm)          | 11-096                          |
|                   | 1" x 2 1/4" (25 mm x 57 mm) 1/4" (6 mm) radius, round corner | 7/8" (22 mm)        | 11-092                          |
|                   | 1" (25 mm) circular drive-in (non-UL)                        | 1" (25 mm)          | 11-105                          |
| 3 3/4"<br>(95 mm) | 1 1/8" x 2 1/4" (29 mm x 57 mm) square corner                | 1" (25 mm)          | 11-103                          |

## Latch front adapter A501-878

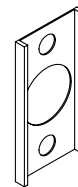

Used to convert 1" wide square front faceplates for 1 1/8" wide door preparations. Furnished in black plastic. Order in units of 100 each.

## Long backsets

Backsets 5" require extension links. A Series locks with long backsets are normally furnished with 1" faceplates and 7/8" housings. Links installed in 1" latch holes require one G506-815 sleeve (order separately) to join latch and link.

## 5" extension link

41-005

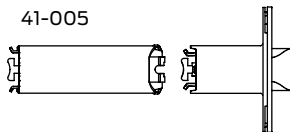

(add to 2 3/8" backset latch)

## Sleeve

G506-815  
(order separately)



## Door reinforcement

Reinforcing unit is required to reinforce and help prevent the collapse of hollow metal doors when locksets are tightly mounted. This kit should be used with long backsets for A Series lock installations in hollow metal doors to prevent lateral movement of the latchbolt. Specify door thickness, 1 3/8" (35 mm) or 1 3/4" (44 mm), when ordering reinforcement kits.

## Reinforcement kit 37-001

Kit includes:

## Reinforcement

A501-566 for 1 3/4" doors or  
A501-565 for 1 3/8" doors

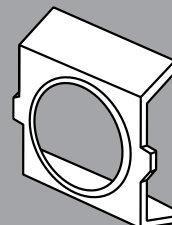



# Strikes

All Schlage strikes are furnished complete with screws. The 10-001 standard A Series strike has a 1 1/8" (29 mm) lip.

Standard strikes shown in bold type.

| Number   | Lip length                                                                                     | Description                                                                |
|----------|------------------------------------------------------------------------------------------------|----------------------------------------------------------------------------|
| 10-001   | <b>1", 1 1/8" (std), 1 1/4", 1 1/2", 1 3/4", 2" (25 mm, 29 mm, 32 mm, 38 mm, 44 mm, 51 mm)</b> | <b>1 1/8" x 2 3/4" (29 mm x 70 mm) square corner, standard</b>             |
| 10-004   | 1 1/8" (29 mm)                                                                                 | 1 1/8" x 2 3/4" (29 mm x 70 mm) 1/8" (3 mm) radius, round corner           |
| 10-025   | 1 3/16", 1 3/8" (30 mm, 35 mm)                                                                 | 1 1/4" x 4 7/8" (32 mm x 124 mm) ANSI                                      |
| 10-026   | 1 1/8" (29 mm)                                                                                 | 1 5/8" x 2 1/4" (41 mm x 57 mm) full lip, square corner                    |
| 10-027   | 1 1/8" (29 mm)                                                                                 | 1 5/8" x 2 1/4" (41 mm x 57 mm) full lip, 1/4" (6 mm) radius, round corner |
| 10-058   | 1 7/32" (31 mm)                                                                                | 1 3/4" (44 mm) circular, adjustable                                        |
| K510-066 | —                                                                                              | Box, ANSI                                                                  |

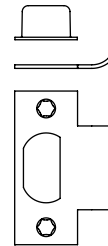

**T-strike – standard**  
10-001

1 1/8" x 2 3/4" x 3/32"  
(29 mm x 70 mm x 2 mm)



**ANSI strike**  
10-025

1 1/4" x 4 7/8" x 3/32"  
(32 mm x 124 mm x 2 mm)

# Rabbeted latch and strike kit

Rabbeted latch and strike kit finishes: 605, 626. This kit adapts square corner latches and strikes for 1/2" (13 mm) rabbeted door and frame preparations.

**Rabbeted latch and strike kit**  
39-030

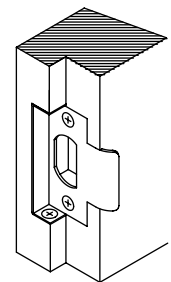
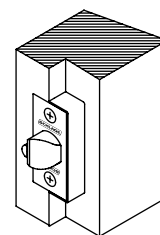

## Specifications

### **Handing:**

Keyed functions are reversible. Non-keyed functions are not handed.

### **Door thickness:**

1<sup>3</sup>/<sub>8</sub>" to 1<sup>7</sup>/<sub>8</sub>" (35 mm to 48 mm) standard.  
2" (51 mm) to 2<sup>1</sup>/<sub>2</sub>" (64 mm) optional extended inside.

### **Backset:**

2<sup>3</sup>/<sub>8</sub>" (60 mm) standard. 2<sup>3</sup>/<sub>4</sub>" (70 mm), 3<sup>3</sup>/<sub>4</sub>" (95 mm) and 5" (127 mm) optional.

### **Front:**

Steel. 1<sup>1</sup>/<sub>8</sub>" x 2<sup>1</sup>/<sub>4</sub>" square corner, beveled, for 2<sup>3</sup>/<sub>4</sub>" backset standard. Optional 1" square corner, 1" radius corner, and non-UL drive-in/round face. For availability with specific backsets, see page 16.

### **Lock chassis:**

Steel, zinc dichromate plated for corrosion resistance.

### **Latch bolt:**

Brass, chrome plated, 1/2" throw, deadlocking on keyed and exterior functions.

### **Exposed trim:**

Wrought brass, bronze or stainless steel. Levers are pressure cast zinc, plated to match finish symbols.

### **Strike:**

T-strike 1<sup>1</sup>/<sub>8</sub>" x 2<sup>3</sup>/<sub>4</sub>" (29 mm x 70 mm) x 1<sup>1</sup>/<sub>8</sub>" (29 mm) lip to center with box standard. Optional strikes, lip lengths and ANSI strike box available. See page 17.

### **Cylinder and keys:**

Commercial: 6-pin patented Everest 29 S123 keyway standard with two nickel silver keys per lock.

Residential: 6-pin C keyway, keyed 5-pin.

### **Keying options:**

Interchangeable core and Primus XP high security cylinders. Master keying, grand master keying, and construction keying.

### **Warranty:**

Commercial: three-year limited.

## Certifications

### **ANSI:**

Meets or exceeds A156.2 Series 4000, Grade 2 strength and operational requirements.

### **Federal:**

Meets FF-H-106C.

### **California state reference code:**

(Formerly Title 19, California State Fire Marshal Standard)  
All levers with a return to door of 1/2" (64mm) or less comply.

### **UL/cUL:**

All locks listed for A label single doors, 4' x 8'.  
Letter F and UL symbol on latch front indicate listing.  
UL437 Listed locking cylinder optional: specify Primus XP 20-500 Series cylinder.

### **ADA compliant:**

Schlage Lock Company offers a wide selection of locks designed to meet the Americans With Disabilities Act.



## About Allegion

Allegion (NYSE: ALLE) creates peace of mind by pioneering safety and security. As a \$2 billion provider of security solutions for homes and businesses, Allegion employs more than 7,800 people and sells products in more than 120 countries across the world. Allegion comprises 23 global brands, including strategic brands CISA®, Interflex®, LCN®, Schlage® and Von Duprin®.

For more, visit [www.allegion.com](http://www.allegion.com)

*aptiQ* ■ LCN ■ **SCHLAGE** ■ STEELCRAFT ■ VON DUPRIN