

2030 Series

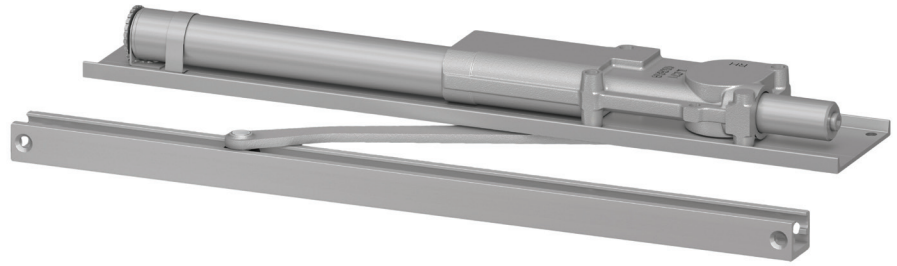

The concealed 2030 Series PACER[®] is a heavy duty closer designed to fit in a narrow, minimum 1 3/4" aluminum transom. The single lever arm and roller assembly provide smooth, quiet door control and the choice of finishes and track functions meet virtually all architectural requirements.

Features

Certifications	Grade 1 - ANSI A156.4, UL 10C, ADA, 100 hour salt spray, meets BAA - Buy American Act	Fasteners	Wood and Machine Screws (WMS)
Body construction	<ul style="list-style-type: none"> Cast iron body Full complement bearing 1 1/8" diameter piston 1/16" diameter double heat treated pinion journal 	Mounting	Concealed (in tube); aluminum frame requires minimum 1-3/4" (44 mm) x 4" (102 mm) tube
Fluid	All weather fluid	Arms	Standard Arm and Track
Handing	Handed	Finishes/colors/ powder coat	<ul style="list-style-type: none"> 689 Aluminum 690 Statuary Bronze 691 Light Bronze 693 Black 695 Dark Bronze 696 Brass Custom colors optional Optional SRI primer - powder coat only Optional plated finishes
Size	Sized 1-5		
Warranty	15 years		

Special templates

Customized installation templates or products may be available to solve non-standard applications. Contact LCN Product Support for assistance.

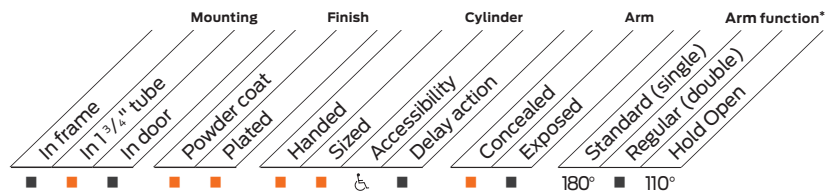

■ Available
■ Not available

♿ Closer available with less than 5.0 lbs. opening force on 36" door.

* Maximum opening/hold open point with standard template. See individual closer series for degrees of opening per installation.

Mounting details

Concealed mounting

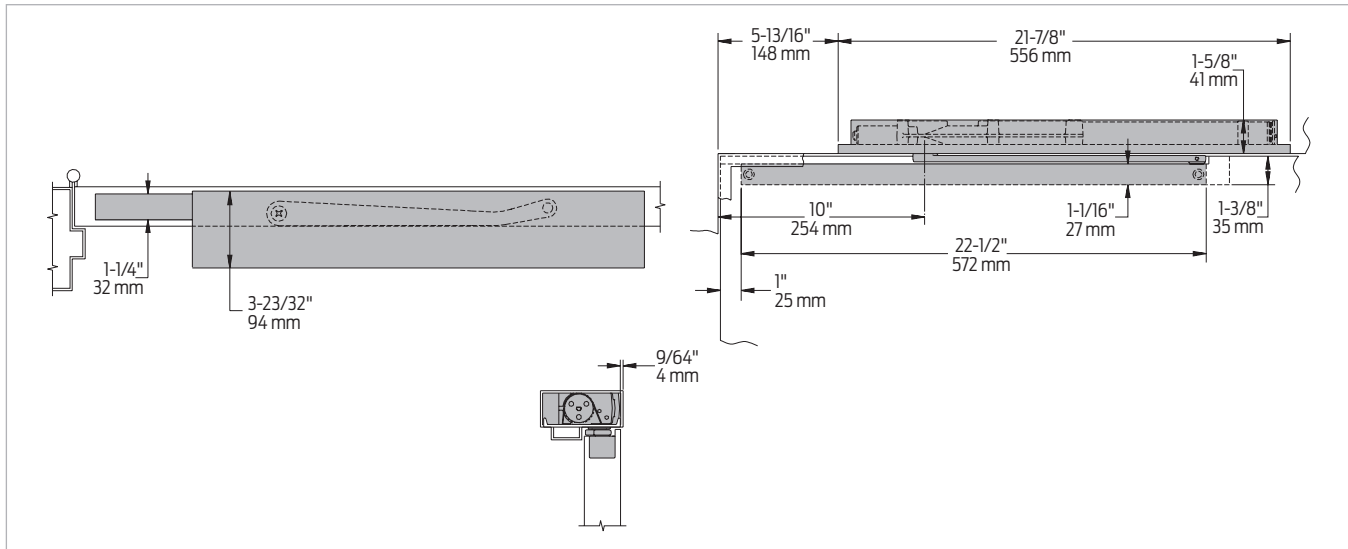

Butt hinges	Should not exceed 5" (127 mm) in width
Auxiliary stop	<ul style="list-style-type: none"> Recommended where a door cannot swing 180° Optional track bumper assembly assists back check in cushioning the opening swing of the door (not intended to replace an auxiliary stop)
Top rail	<ul style="list-style-type: none"> 1 3/8" (35 mm) mortise required With Fire Shield, 1 13/32" (36 mm) mortise required 5/16" (8 mm) cutout required at top of the door, stop face only
Door thickness	1 3/4" (44 mm) minimum
Hollow metal frame	Consult factory for installation instructions
Wood frame	Installation simplified by Wood Mounting Clip Set 2030-416 for center pivoted or 2030-417 for offset pivoted and butt hung installations. Consult factory for preparation details.
Maximum opening	<ul style="list-style-type: none"> Butt hinge template allows 180°, trim permitting Limited to 110° when optional bumper is installed Adjustable hold open points from 85° to 110°, with Hold Open Track (H) Consult factory if door will be held open at 180° Offset pivot template allows 115°, trim permitting. Limited to 95° when optional bumper is installed Hold open point from 85°, with Hold Open Track (H) Center pivot template allows 120°, trim permitting Limited to 100° when optional bumper is installed Adjustable hold open points from 85° to 100°, with Hold Open Track (H)

Notes:

- For interior or exterior doors
- Single acting cylinder in head frame
- Concealed arm and track in door top rail

Accessories

Cylinders



**2031(2)(3)(4)(5)-3071
Cast iron cylinder assembly
with mounting plate (CYL)**

- Handed
- With mounting plate
- Standard

Arms



**2030-3077T
Standard Arm (STDTRKARM)**

- Handed
- Track roller not included with arm

Tracks



**2030-3038
Standard Track (STDTRK)**

- Non-handed
- Non hold open
- Will accept hold open clip and/or bumper assembly
- Standard



**2030-3038B
Track with Bumper (BUMP)**

- Non-handed
- Non hold open
- Will accept hold open clip
- Optional



**2030-3038H
Hold Open Track (H)**

- Non-handed
- Will accept bumper assembly
- Optional



**2030-3038HB
Hold Open Track with Bumper (HBMP)**

- Non-handed
- Optional

Installation accessories



**2030-420
Fire Shield**

- 22 gauge steel liner mounts in the track mortise of the door's top rail for 20 minute labeled wood doors

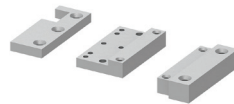

**2030-416
Wood Mounting Clip Set**

- Simplifies mounting center pivoted 2030 closer in wood frame
- Includes latch stile clip, hinge stile clip and cover
- For use with Ives center pivots
- Consult factory for special template

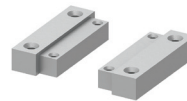

**2030-417
Wood Mounting Clip Set**

- Simplifies mounting offset pivoted or butt hung 2030 closer in wood frame
- Includes two clips
- For use with offset pivots
- Consult factory for special template



**2030-169
Track Bumper**

- Mounts in track to assist back check
- Limits maximum opening
- Consists of bumper, bumper post and mounting screw

Note: Track bumper does not replace auxiliary stop.

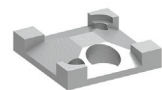

**2030-3054
Hold Open Clip**

- Mounts in track to provide hold open function
- Hold open point controlled by clip location
- Requires 2030-3034H Hold Open Track Roller



**2030-3034
Track Roller**

- Quiet, low friction roller assembly
- Shoulder dimension "X" = 1/16" (2 mm)



**2030-3034H
Hold Open Track Roller**

- Quiet, low friction roller assembly
- Shoulder dimension "X" = 1/16" (2 mm)

2030 Series

Ordering information

How-to-order 2030 Series closers

1. Select cylinder size

- 2031
- 2032
- 2033
- 2034
- 2035

2. Specify hand

- Right Hand (RH)
- Left Hand (LH)

3. Select finish

- Standard powder coat _____
Aluminum (689), Dark Bronze (695), Statuary Bronze (690), Light Bronze (691), Black (693), or Brass (696)

Closer will be shipped with:

- Standard cylinder with mounting plate
- Standard arm
- Standard track
- Wood and machine screws
(unless options listed below are selected)

Closer options

Track

- Track with Bumper (BUMP)
- Hold Open Track (H)
- Hold Open Track with Bumper (HBMP)

Finish

- Custom powder coat (RAL) _____
- Plated finish _____
- SRI primer (use with powder coat finishes only)

Screw pack

- Torx Machine Screws (TORX)

Installation accessories

- Fire Shield, 2030-420
- Wood Clip Set, 2030-416
- Wood Clip Set, 2030-417

Special template

- ST- _____

Table of sizes

- Select closer based on width of door.
- 2030 Series cylinders available in size 1, 2, 3, 4, or 5
- Closing power of all 2030 Series closers may be increased 35%
- Specify next higher size closer where strong drafts exist

Exterior (and vestibule) door width

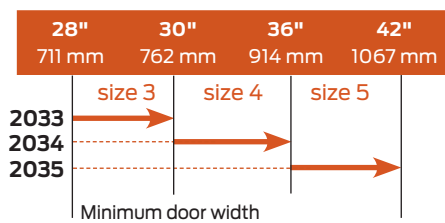

Interior door width

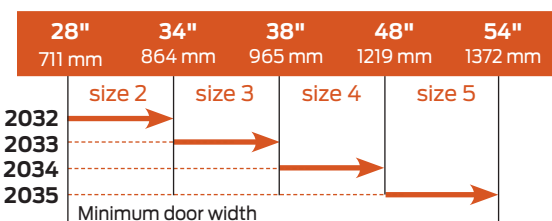

→ Indicates recommended range of door width for closer size.

Reduced opening force 2030 Series closers

CAUTION! Any manual door closer, including those certified by BHMA to conform to ANSI Standard A156.4, that is selected, installed and adjusted based on ADA or other reduced opening force requirements may not provide sufficient power to reliably close and latch a door.

Refer to Automatic Operators catalog for information on systems that meet reduced opening force requirements without effecting closing power.

Door width	36"	42"	48"
 8.5* lbs.	2033	2033	2034
5.0* lbs.	2031	2032	2032

* Maximum opening force.